

1 **EXAMPLE POST LAYOUT**
PLAN VIEW

AGS Stainless Clearview® Railing Systems are designed to meet the requirements of the latest edition of the IRC/IBC.

NOTES:

1. TOP RAIL NOT SHOWN FOR CLARITY.
2. ALL PARTS AND COMPONENTS MADE WITH 316 STAINLESS STEEL UNLESS NOTED OTHERWISE.

LEGEND

- DETAIL ID
- SHEET ID
- ELEVATION ID
- SHEET ID
- TOP MOUNT POST
- TOP MOUNT DOUBLE POST
- CENTERLINE
- FINISHED FLOOR
- TYP TYPICAL CONDITION APPLIES ELSEWHERE AT SIMILAR CONDITIONS

NOTES:

1. TOP RAIL SHOULD BE SELECTED SO THAT ALL GOVERNING CODE REQUIREMENTS ARE SATISFIED. THESE INCLUDE SHAPE, STRENGTH AND RAILING HEIGHT.
2. DECK STRUCTURE CAN VARY GREATLY. IT IS THE RESPONSIBILITY OF THE CUSTOMER TO VERIFY THAT THE SUPPORTING STRUCTURE IS ADEQUATE TO MEET THE LOAD REQUIREMENTS OF THE GOVERNING BUILDING CODE(S). AGS Stainless Inc. RECOMMENDS CONSULTING A DESIGN OR CONSTRUCTION PROFESSIONAL TO ADDRESS THESE ISSUES.

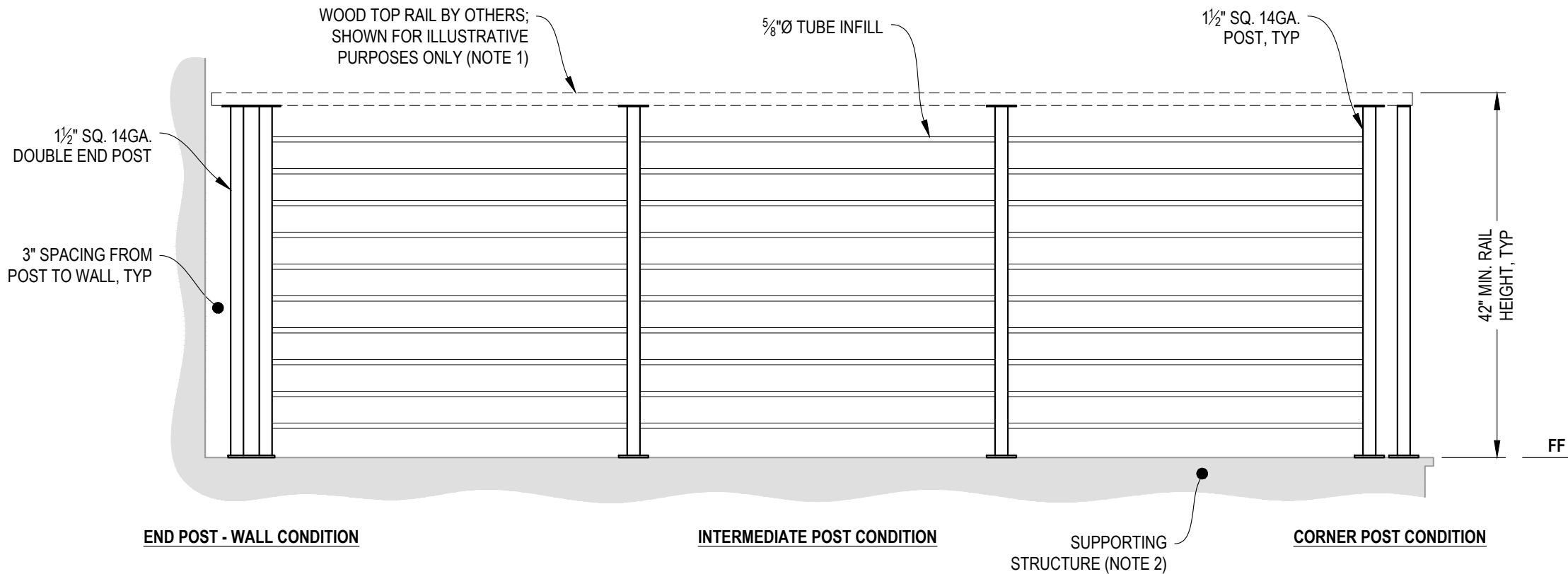

A **TYPICAL RAILING CONDITION**
ELEVATION

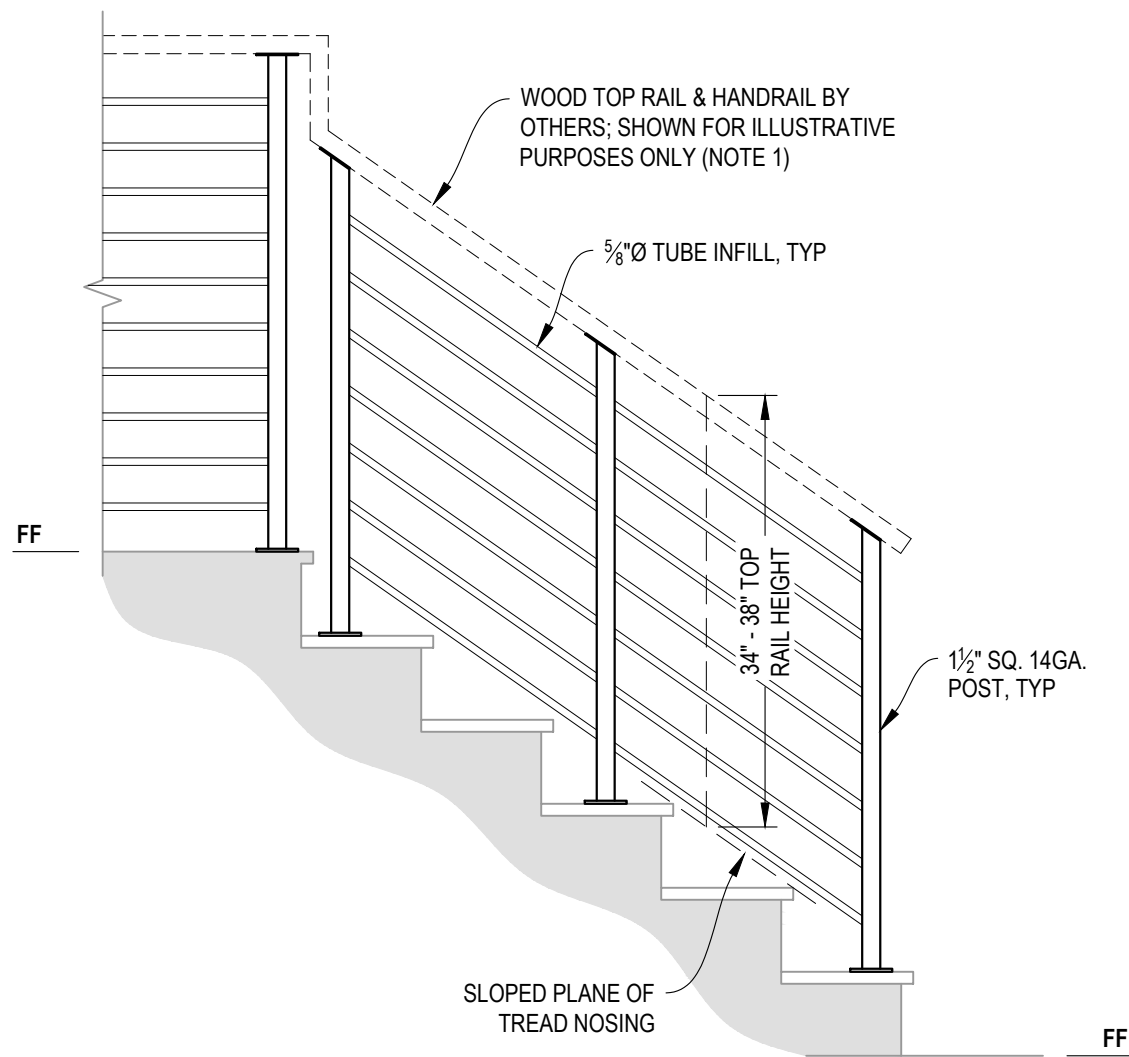

A STAIR
ELEVATION

NOTES:

1. TOP RAIL SHOULD BE SELECTED SO THAT ALL GOVERNING CODE REQUIREMENTS ARE SATISFIED. THESE INCLUDE SHAPE, STRENGTH, AND RAILING HEIGHT.
2. STAIR CONSTRUCTION VARIES GREATLY. AS-BUILT CONDITIONS MAY ALTER RAILING DESIGN, INCLUDING POST LOCATION & MOUNTING, INFILL SPACING, AND TOP RAIL LAYOUT.

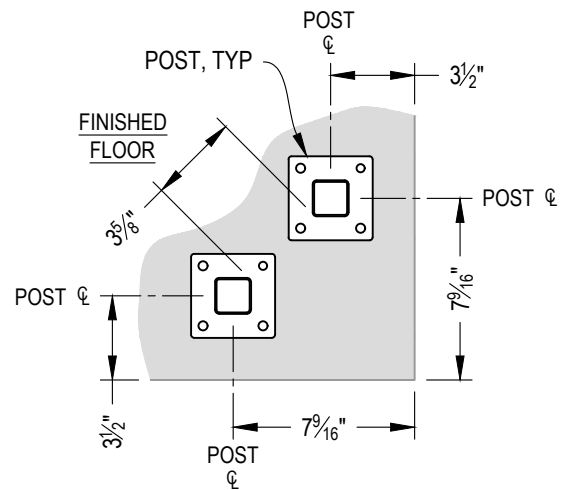

NOTE: 90° SHOWN, OTHER ANGLES SIMILAR

A TYPICAL 90° TOP MOUNT OUTSIDE CORNER
DETAIL

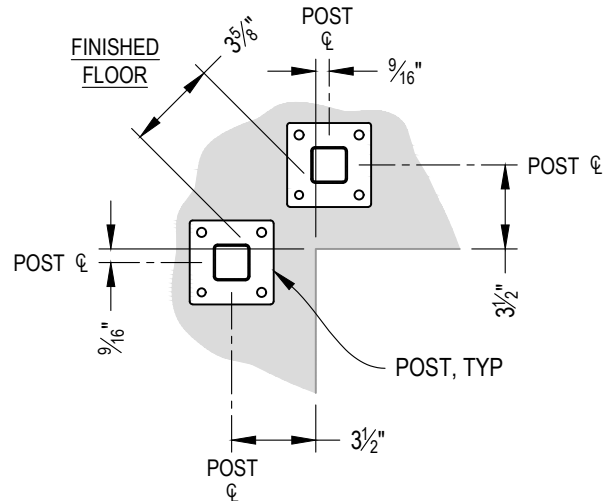

NOTE: 90° SHOWN, OTHER ANGLES SIMILAR

B TYPICAL 90° TOP MOUNT INSIDE CORNER
DETAIL

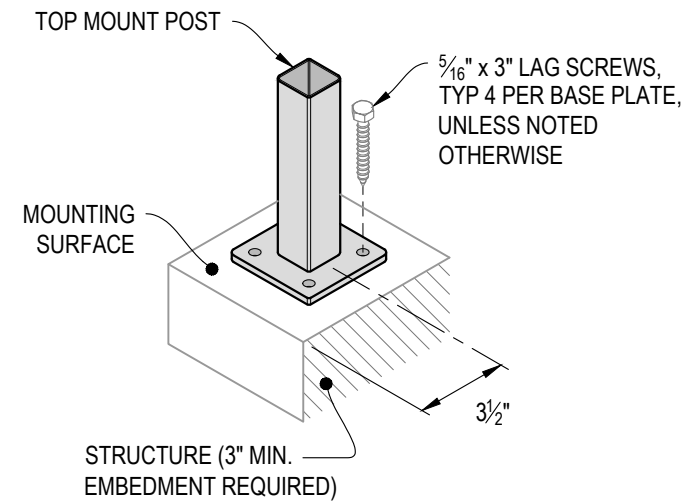

C TYPICAL POST MOUNTING - TOP MOUNT
DETAIL



D TYPICAL BASE PLATE
DETAIL

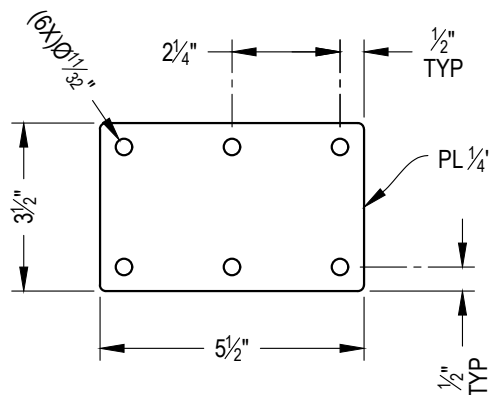

E TYPICAL DOUBLE BASE PLATE
DETAIL

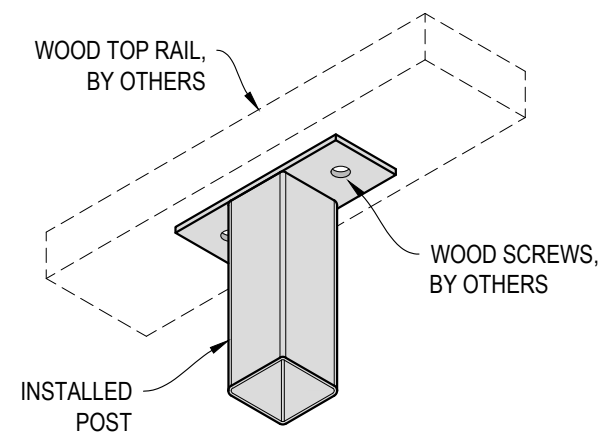

F TOP RAIL INSTALLATION - WOOD
DETAIL

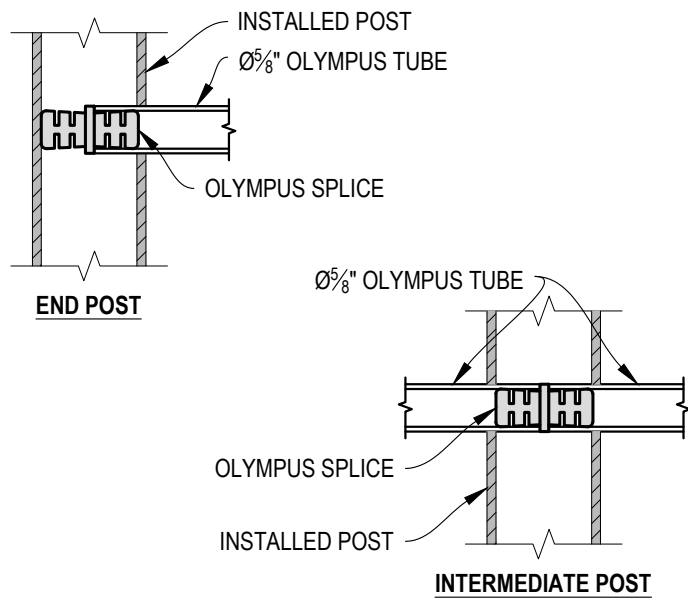

A FITTING INSTALLATION - OLYMPUS SPLICE
DETAIL

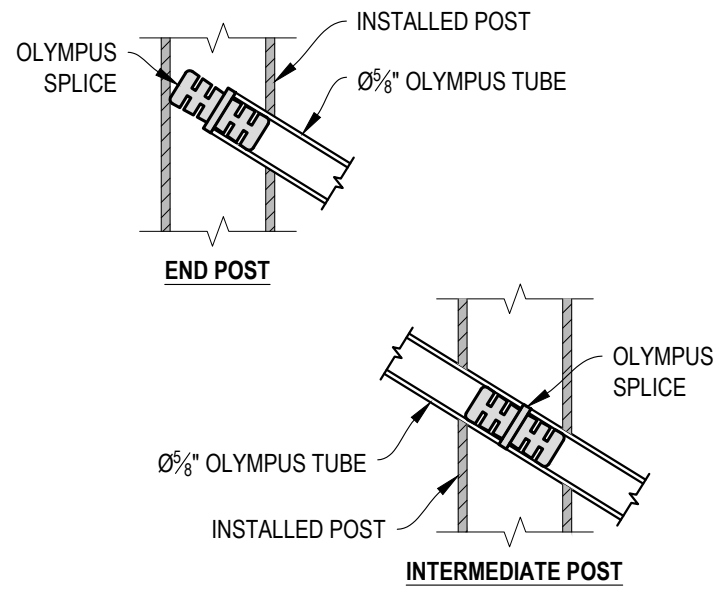

B FITTING INSTALLATION - OLYMPUS SPLICE
DETAIL